

Columbus Day Activity Book

12



I can connect the dots.



Columbus Day Activity Book

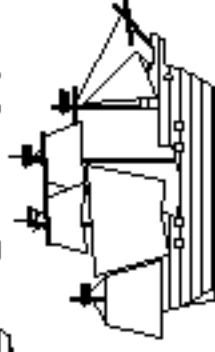
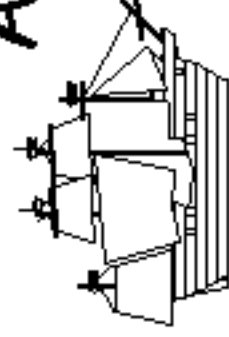
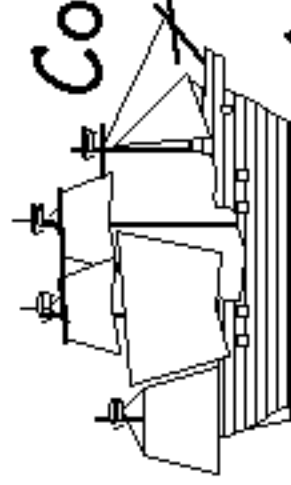

By _____

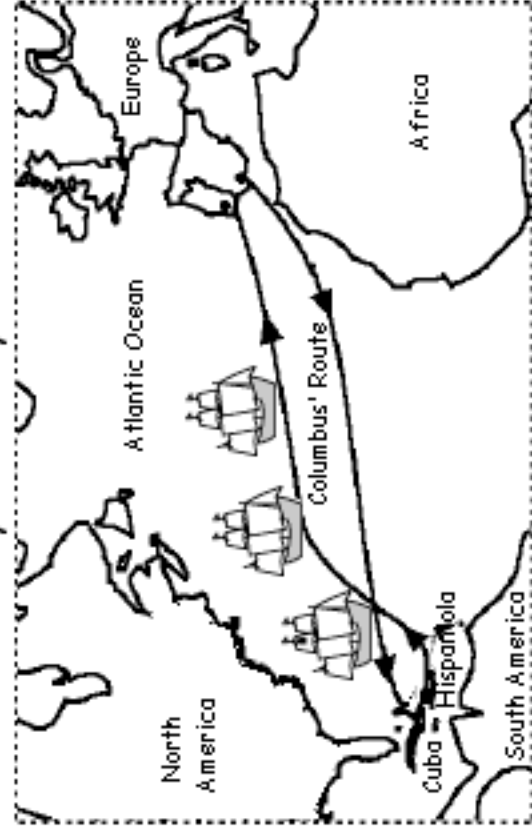

COLOR:

Red - Europe

Orange - North America.

Green - Africa.

Pink - South America.

Blue - Oceans and seas

Yellow - Ships

In 1492, Columbus sailed from Palos, Spain, with 90 men and three ships, the Niña, Pinta and Santa Maria. In 5 weeks, they reached the West Indies, where the Santa Maria sank; the Niña and the Pinta later returned to Europe.

©EnchantedLearning.com

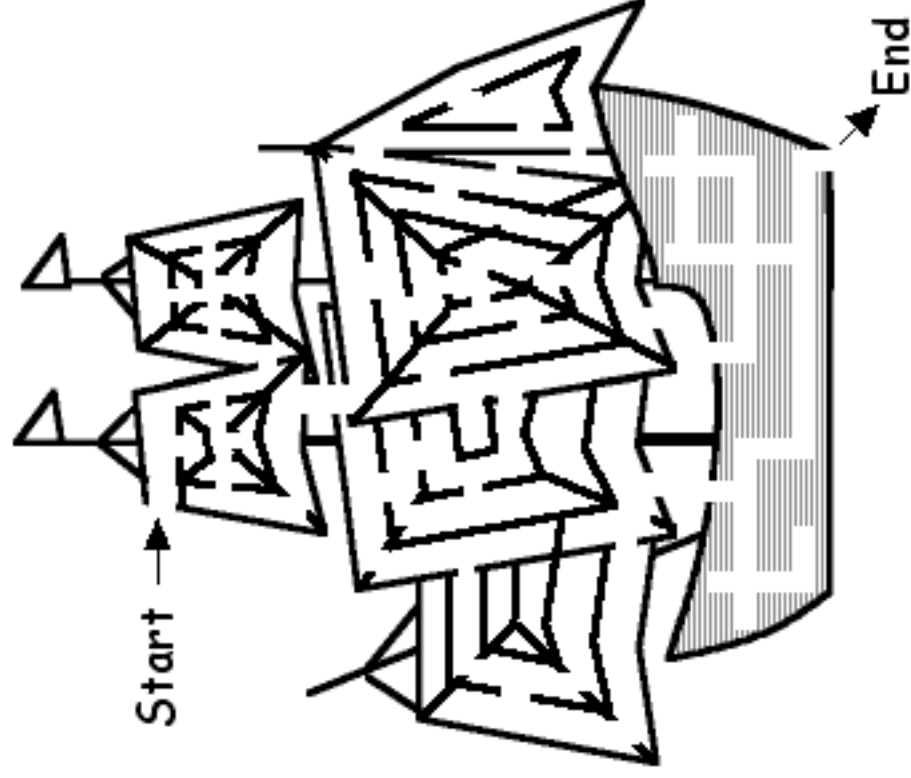

I can solve the maze.

©EnchantedLearning.com

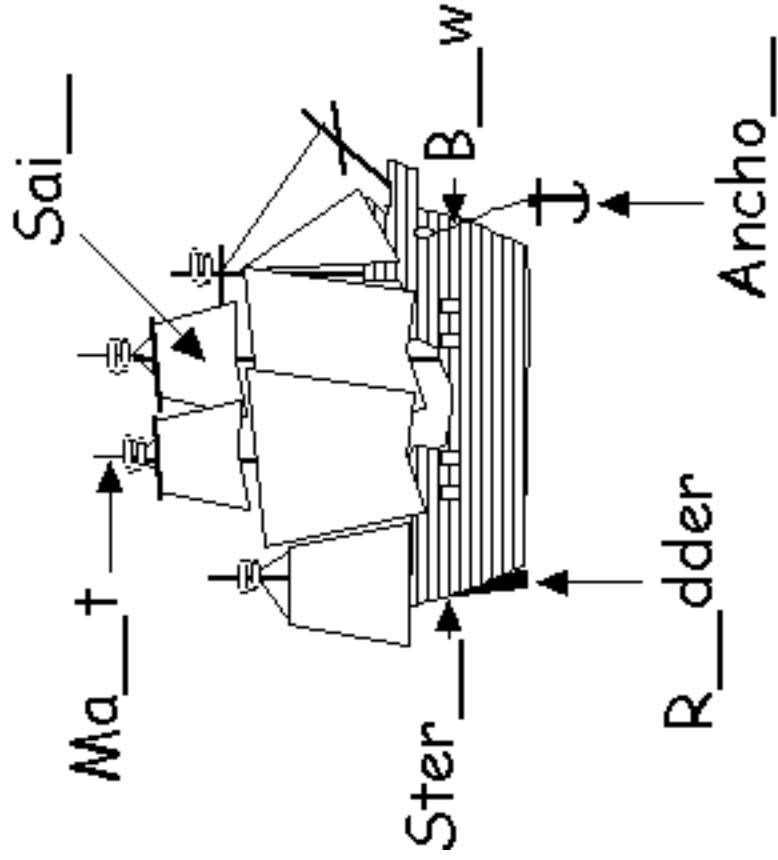

I can fill in the letters. The bow is the front of a ship, the stern is the back. The masts support the sails. The rudder is used to steer the ship.



Match the sails.

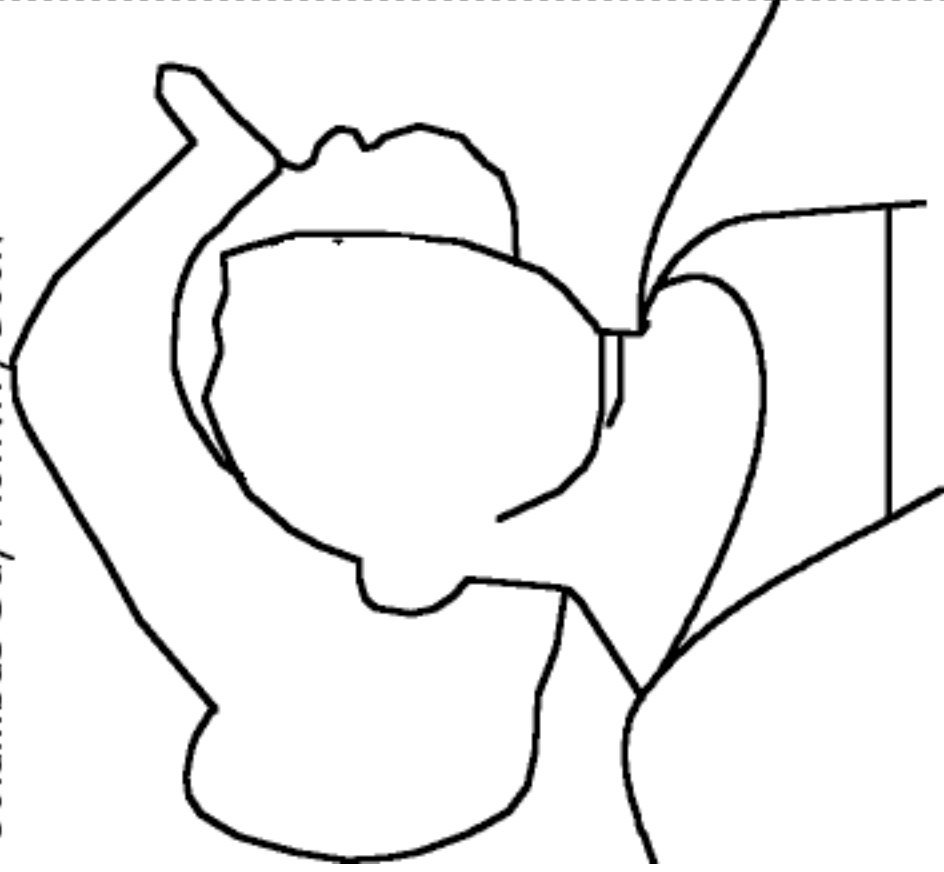

I can finish the drawing.

eas	

ript	

eerht	

sihps	

pecsi	

uteor	

I can unscramble the words.

Columbus Day Activity Book

S A N T A M A R I A D
P L I O T R I P L N
I L N E E U Q R C U A
C E A S P E O C E A N
E B H T P I N T A M I
S A R N E W W O R L D
C S U B M U L O C B R
K I N G S H I P U E
A T L A N T I C O S F

Atlantic
Columbus
Ferdinand
Isabella
King

New World
Nina
ocean
Pinta
Queen

Santa Maria
ship
spices
trip

The extra letters spell:

Columbus Day Activity Book

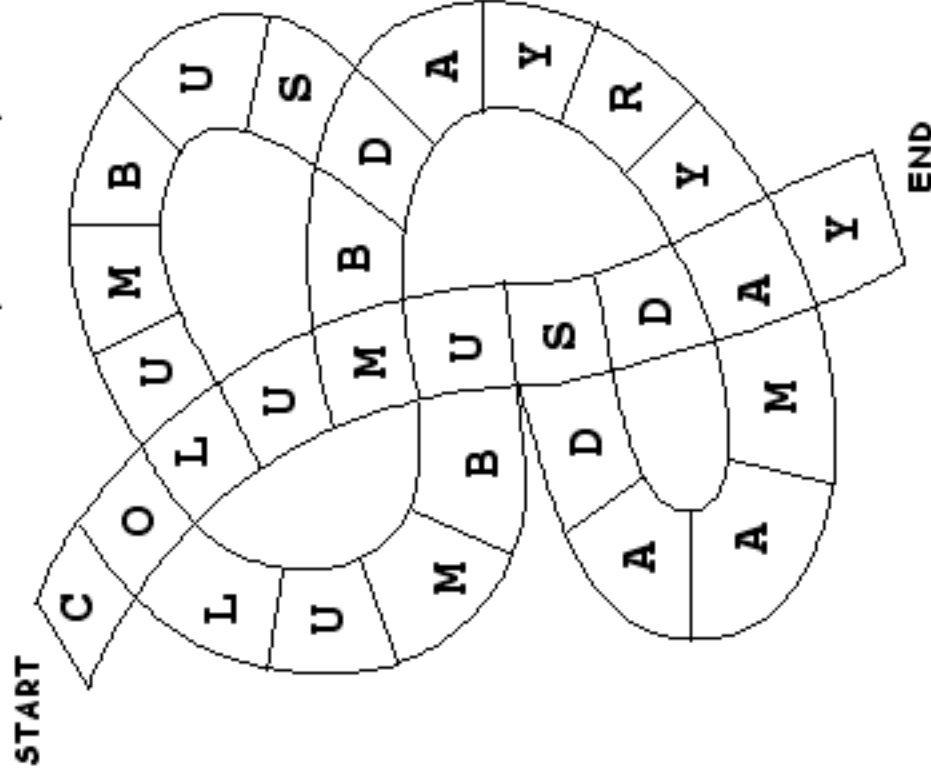

I can spell COLUMBUS DAY.